

# Shimano Nexus Inter-7 SG-7R:

## How it works

W.Pasman, 9 march 2012

### Introduction

This manual describes how the Shimano Nexus Inter-7 hub works. There are several Shimano patents describing the working details of similar internal hubs [1-5] but to my knowledge none specifically about the Shimano Nexus Inter-7 hub. Also, while these patents are very precise about the exact functioning of all internal parts, they are not very illuminative in describing how the mechanism works as a whole. This document is an attempt to improve on Shimano's documentation.

The document starts with a review on how planetary gear systems work, and the basic mathematical formulas that we need for the Nexus-7. Then we dive into the Nexus.

### Planet gears in various states

The hub uses planet gears which rotate at different speeds, depending on how they are configured. This section derives the basic mathematical equations governing the planet gears that give rise to the various gear ratios. If you are familiar with compound planet gears, you can skip this section.

This section starts with fundamentals of planetary gearing. Then formulas for stepped compound planet gears with locked sun gear are derived. Finally, the blocking direction of the sun gears is checked.

#### *Basic planetary gear*

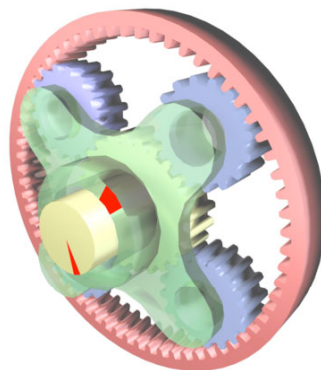
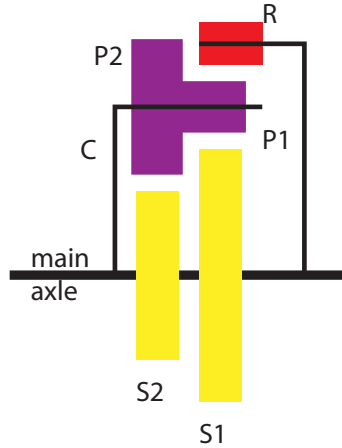

**Figure 1. Planet gear. Yellow in the center is the sun gear; purple are the planetary gears, and red is the ring gear. Green is the planet cage.**

For those unfamiliar with planet gears, Figure 1 shows a basic planetary gear system with sun gear, planetary gears, ring gear and planet cage.

## Compound planet gears

We now examine a more complex system with two sun gears and stepped planet gears. Figure 2 shows the cross section. The cage is considered to be the input, and the ring gear the output of the gear mechanism. Furthermore, looking at the Nexus 7, we assume that each of the sun gears can independently be either **locked** to the axle (we also say that the gear is **engaged**), or rotate freely (unlocked or disengaged). The axle is considered to be stationary (non-rotating), as in a bicycle hub.



**Figure 2. Basic planetary gear system with two sun gears S1 and S2, one stepped planet gear P1/P2 in a cage C, and one ring gear R. Both sun gears, the cage and ring gear can rotate around the shaft. The two planet gears are rigidly connected to one another.**

As a notation convention, we indicate the number of teeth on a gear with a #, so  $\#P_2$  is the number of teeth on gear  $P_2$ .  $P_2$  (without #) refers to the number of turns that gear  $P_2$  makes.

First we consider the case where  $S_2$  is locked to the axle, and  $S_1$  is free. We give the planet cage one turn and look at what happens at the ring gear.

If the cage were just locked to the ring gear, the ring gear would go through one full turn as well. The ring gear turns farther, because the locked sun gear forces the planet gear to rotate.

The planet gear makes  $N = \#S_2/\#P_2$  turns around the sun gear if the cage makes one full turn.  $P_1$  turns by the same amount. Each turn of  $P_1$  will cause the ring gear to rotate  $\#P_1/\#R$  turns. So, one turn of the planet cage results in  $N$  turns of the planet gear and  $(\#S_2/\#P_2)(\#P_1/\#R)$  turns of the ring gear.

Adding the one turn that we would have if the ring gear and cage were just locked to each other, one turn of the planet cage gives  $1 + (\#S_2/\#P_2)(\#P_1/\#R)$  turns of the ring gear. The ratio of the number of turns of R per turn of C, or R/C, or gear ratio, is

$$\left. \frac{R}{C} \right|_{\text{sun2 locked}} = 1 + \frac{\#S_2\#P_1}{\#P_2\#R} \quad (1)$$

Driving the planet cage makes the ring gear rotate faster.

Note that we can just as well drive R instead of C to get a reduction instead of an increase.

Now let us consider the case where  $S_1$  is locked to the axle and  $S_2$  is free. In this case,  $P_2$  and  $S_2$  are in fact not necessary, as they rotate but do not drive the ring gear. We can use the previous formulas, setting  $\#P_2 = \#P_1$  and  $\#S_2 = \#S_1$  giving us:

$$\frac{R}{C} \Big|_{sun1 \text{ locked}} = 1 + \frac{\#S_1}{\#R} \quad (2)$$

Note that necessarily  $\#R > \#S_1$  and the gear ratio therefore always will be between 1 and 2.

In our application, sun gear 1 is larger than sun gear 2 and planet gear 1 is smaller than planet gear 2. Then, we have

$$\begin{aligned} \#S_1 > \#S_2 \text{ and } \#P_2 > \#P_1 &\Rightarrow \#S_1 \#P_2 > \#S_2 \#P_1 \Rightarrow \\ \frac{R}{C} \Big|_{sun1 \text{ locked}} = 1 + \frac{\#S_1}{\#R} &> \frac{R}{C} \Big|_{sun2 \text{ locked}} = 1 + \frac{\#S_2 \#P_1}{\#P_2 \#R} \end{aligned} \quad (3)$$

So the larger sun gear results in the larger gear ratio.

### ***Locking direction of sun gears***

In this section we look at the required locking direction for the sun gears.

Generally, the **input torque is clockwise** when looking at the axle from the right, as in Figure 3. The other direction of rotation does not need to be provided for, as the pedals freewheel if you backpedal.

The input torque can be applied either to the ring gear, or to the cage, and then vice versa for the output torque.

First we consider the case where the input torque is applied to the ring gear. Now if both the sun gears were unlocked, the planet cage would be unable to provide torque to the output, and the ring gear would not rotate. Instead, the sun gear would spin **counterclockwise**, because the planet gear reverses the direction of rotation. So in this case, one or the other sun gear must be prevented from turning counterclockwise.

Now consider the case where the input torque is on the cage. If the sun gears are unlocked, the ring would be unable to provide torque on the output and would not spin. Then the sun gears would spin **clockwise**, along with the planet cage. In this case, the sun gears only need to be prevented from turning clockwise.

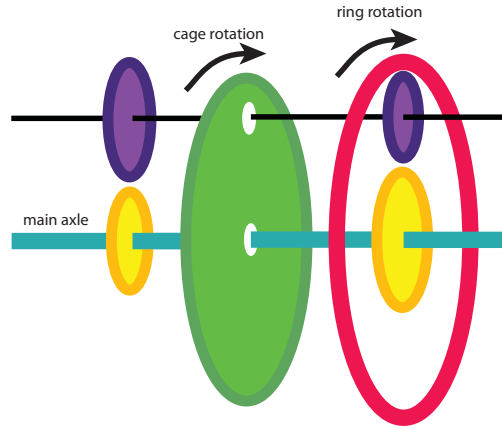

**Figure 3.** As Figure 2 but in a slightly oblique view to clarify the rotation of gear ring and planet cage.

### **Rotation of free sun gear**

Now we examine the rotation of the free sun gear. Suppose the blocked gear is  $S_1$  and the free one is  $S_2$ . As before, to determine what happens, we first assume that the planet gear is locked to the cage, and makes one full turn with the cage (which rotates both sun gears). Next, we hold the cage from turning, and rotate sun gear  $S_1$  that was supposed to be locked back into its start position by a full turn.

The full turn of the planet cage turns both sun gears backward by one turn. The rotation of  $S_1$  results in a rotation of  $\#S_1/\#P_1$  turns of the planet gear, and in a backward rotation of  $(\#P_2/\#S_2)(\#S_1/\#P_1)$  turns of  $S_2$ . So we have

$$\left. \frac{S_2}{C} \right|_{sun1 \text{ locked}} = 1 - \frac{\#S_1\#P_2}{\#S_2\#P_1} \quad (4)$$

In this formula you can swap all indices 1 and 2 to get the formula with sun gear 2 blocked. Note that the result may be negative, and then the rotation of the sun gear is opposite that of the planet cage.

If sun gear 1 is blocked, sun gear 2 rotates opposite the direction of rotation of the planet cage if and only if  $\frac{\#S_1\#P_2}{\#S_2\#P_1} > 1 \Rightarrow \#S_1\#P_2 > \#S_2\#P_1$ . This happens when sun gear 1 is larger than sun gear 2.

Summarizing, the free sun gear rotates opposite the direction of rotation of the planet cage  $\Leftrightarrow$  it is smaller than the locked sun gear. This also holds for the case where gear 2 is blocked.

## How the Nexus-7 works

A few main components establish how the hub works. Proceeding from the outside inwards toward the axle:

1. The coupling of two planetary gearing systems so the planet cages rotate at the same speed
2. How blocked sun gears are used to achieve different gear ratios
3. The resulting gear ratios for the Nexus
4. The three ways to block or free the sun gears
5. Optimizations

### Two planet gearing systems in one hub

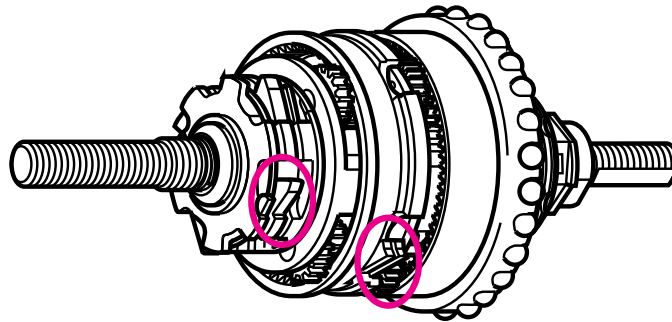
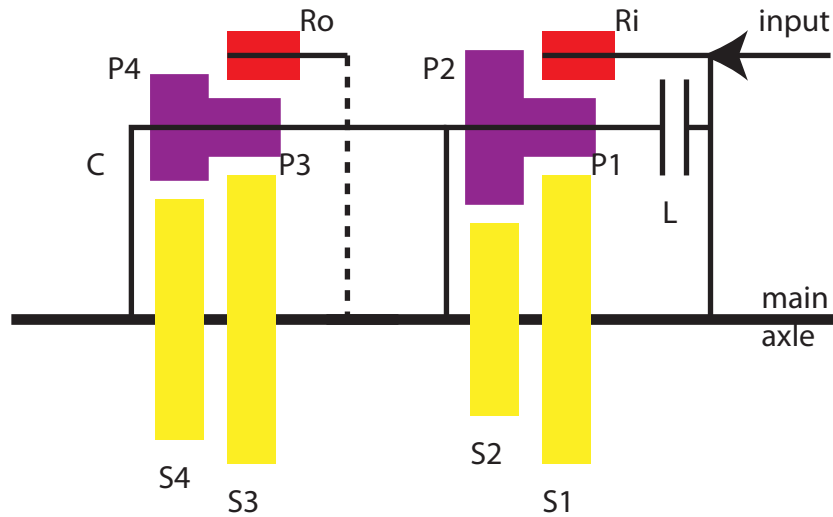

**Figure 4. internal assembly with various parts rotating at different speeds.**

The outside of the internal assembly has various parts, all rotating at different speeds. At the outside of the internal assembly are two sets of pawls (Figure 4). These engage with ratchets in the inside of the hub shell. The pawls on the fastest rotating ring will drive the hub; the slower ratchet will freewheel.

### The Nexus 7's gears

Inside the hub, the Nexus 7 planetary gear configuration consists of two compound planetary gearing systems (Figure 5), the first (right) one acting as a reduction gear and the second (left) as an increase gear. Power is applied to the input ring  $R_i$ . An additional element is a clutch  $L$  that can lock the driver to the right-side planet cage.



**Figure 5.** A schematic diagram of the Nexus Inter-7 shows two compound gearing systems and a clutch L. The two planet cages are locked together and rotate at the same speed. The dashed line from  $R_o$  to the axle is to make clear that it does not connect with planet cage C.

Output may occur either at ring gear  $R_o$  or at planet cage C. As was discussed in "Two planet gearing systems in one hub" the faster one drives the hub.

Clutch L is engaged when  $S_1$  and  $S_2$  are both free, resulting in a 1:1 ratio of input  $R_i$  and planet cage C.

Either  $S_1$ ,  $S_2$  or L is blocked, driving planet cage C at different speeds, and either  $S_3$  or  $S_4$  or neither is blocked. so  $R_o$  is driven at different speeds (or not driven, in which case planet cage C drives the hub).

## Gear Ratios

The gear ratios of the Nexus 7 can be computed From the considerations above and the actual number of teeth on each gear.

**Table 1.** Number of teeth of gears in Nexus 7.

Gear	$R_i$	$S_1$	$S_2$	$P_1$	$P_2$	$R_o$	$S_3$	$S_4$	$P_3$	$P_4$
#teeth	72	42	36	14	20	66	36	30	14	19

For the first compound gearing system, we use formulas 1 and 2, but inverting them, as R is the input instead of the output:

$$\left. \frac{C}{R_i} \right|_{sun1 \text{ locked}} = \frac{\# R_i}{\# R_i + \# S_1} \text{ and } \left. \frac{C}{R_i} \right|_{sun2 \text{ locked}} = \frac{\# P_2 \# R_i}{\# P_2 \# R_i + \# S_2 \# P_1}$$

**Table 2. Gear ratios for compound gearing system1.**

<b>locked</b>	<i>L</i>	<i>S1</i>	<i>S2</i>
<b>C/Ri</b>	1	12/19	20/27

For the second compound gearing system, we use equations 1 and 2 'as is', though of course the actual gears are different:

$$\frac{R_o}{C} \Big|_{sun3 \text{ locked}} = 1 + \frac{\# S_3}{\# R_o} \quad \text{and} \quad \frac{R_o}{C} \Big|_{sun4 \text{ locked}} = 1 + \frac{\# S_4 \# P_3}{\# P_4 \# R_o}$$

**Table 3. Gear ratios for compound 2.**

<b>locked</b>	<i>none (out=C)</i>	<i>S3 (out=Ro)</i>	<i>S4 (out=Ro)</i>
<b>out/C</b>	1	17/11	279/209

Straight multiplication of all possibilities gives us the results in Table 4:

**Table 4. All possible combinations of the compound gearing systems, and resulting gear ratios. The combinations marked '-' are not used.**

<b>blocked in compound gearing system 1</b>	<b>blocked in compound gearing system 2</b>	<b>ratio</b>	<b>Decimal ratio, rounded</b>	<b>gear number</b>
<i>L</i>	<i>none</i>	1	1.0	-
	<i>S3</i>	17/11	1.545	7
	<i>S4</i>	279/209	1.335	6
<i>S1</i>	<i>none</i>	12/19	0.632	1
	<i>S3</i>	204/209	0.976	-
	<i>S4</i>	3348/3971	0.843	3
<i>S2</i>	<i>none</i>	20/27	0.741	2
	<i>S3</i>	340/297	1.145	5
	<i>S4</i>	620/627	0.989	4

Note that Shimano uses the odd combination S2/S4 instead of the flat-out 1.0 ratio for gear 4, so there is no "direct drive". This serves to make shifting smoother between gears 4 and 5, and avoids having to disengage the drive between gears, with the possibility of the hub's freewheeling forward.

We can sort the table by final ratio, as in Table 5:

**Table 5. gears in order, with locked sun gear numbers**

gear nr	ratio	blocked in compound gearing system 1	blocked in compound gearing system 2
1	12/19	<i>S1</i>	<i>none</i>
2	20/27	<i>S2</i>	<i>none</i>
3	3348/3971	<i>S1</i>	<i>S4</i>
4	620/627	<i>S2</i>	<i>S4</i>
5	340/297	<i>S2</i>	<i>S3</i>
6	279/209	<i>L</i>	<i>S4</i>
7	17/11	<i>L</i>	<i>S3</i>

## Blocking the sun gears

Blocking and freeing the sun gears is controlled in three ways: by one-way ratchets, by the main control sleeve, and by the gear shifting cam (the 'clutch' in Figure 5).

### The main control sleeve

At the core of the hub (literally and functionally) is the main control sleeve. This sleeve frees up or blocks the sun gears as described in Table 5. Figure 6 through Figure 9 show how this is done.

The slots on the axle form a ratchet: the pawls don't engage them when turning in one direction, but when turned in the other direction they engage.

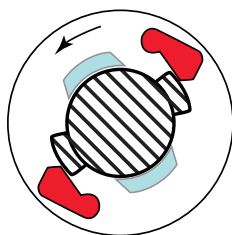

**Figure 6.** When the pawls (red) rotate counter-clockwise, they do not engage with the slots (striped). The sleeve (blue) is not doing anything in this case.

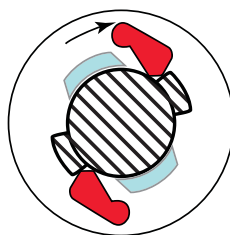

**Figure 7.** When the pawls rotate clockwise, they engage with the slots. The sleeve is away from the slots so as not to interfere.

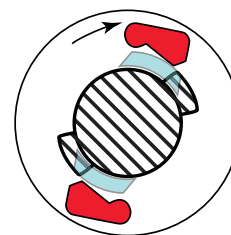

**Figure 8.** When the sleeve overlaps with the slot while rotation is clockwise, the sleeve lifts the pawls over the slots and the pawls do not engage.

The main control sleeve enables or disables the ratchets. The pawls are widened up a bit, so that part of their width does not meet the slots but instead meets the control



sleeve. The control sleeve is made with a slanted leading edge, such that the pawls don't engage with it but instead are lifted up. Now if the control sleeve is far away from the edge of a slot, the pawls fall into the slot and engage (Figure 7), but if the control sleeve overlaps with the slot, they are lifted over the slot (Figure 8).

Figure 9 is a photo with the main control sleeve colored red for clarity. A pawl (shown separately at the bottom, without its enclosing sun gear) normally travels over the shaft (see the wear track there). It can engage if it travels "upward" over this area, when it meets the slot at the far top of that track. In the state shown in the photo, the control sleeve overlaps with the slot and will lift the pawl and drop it after the slot, where it cannot engage. If the control sleeve were rotated further downward, the pawl would drop down before the slot and engage.

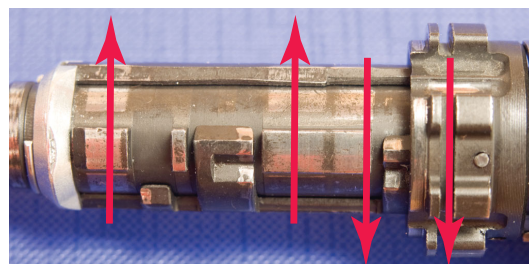

**Figure 9.** slots, control sleeve (in red) and pawl (at bottom). The pawl is shown in the same orientation as it would have if placed on the axle.

The main control sleeve controls three sun gears, as shown in Figure 10. The fourth sun gear is  $S1$ , controlled by only a ratchet, as discussed below. Figure 11 shows the direction in which the four sun gears engage (see the section Locking direction of sun gears ).



**Figure 10.** The three sun gears  $S4$ ,  $S3$  and  $S2$  (left to right) controlled by the control sleeve.  $S4$  is captive inside planet cage 2.



**Figure 11.** Red arrows show the direction of engagement of the 4 sun gears, shown on top of the control sleeve and ratchet.

Figure 12 shows four of the seven positions of the control sleeve. In (p1), none of the sun gears engages with the shaft. This is the position that the return spring pushes toward, and this is the lowest gear position. Position (p3) makes the left sun gear  $S4$  engage. In (p6),  $S3$  does not engage but  $S2$  does. All sun gears engage in (p7).

**Figure 12. Four positions of the control sleeve.**

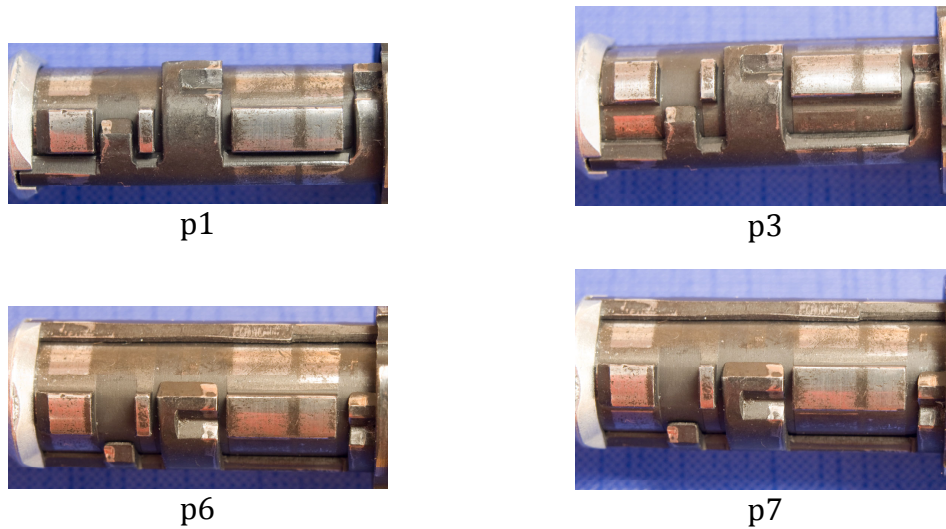

### ***Gear shifting cam***

The gear-shifting cam implements the clutch  $L$ . The gear shift cam is controlled by the feed cam rotation, which in its turn is directly controlled by the shifter sleeve. The feed cam has a cutout. In the high gears 6 and 7, the cutout allows the gear-shifting cam to pop out of the driver unit, thereby releasing the pawls of the driver unit. These pawls then engage with the right-side planet cage. In the lower gears, the feed cam pushes the gear shifting cam between the pawls, releasing the clutch.

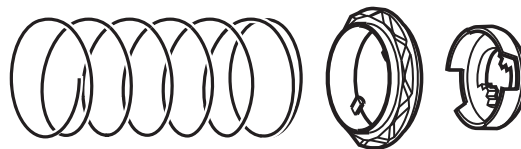

**Figure 13. From left to right the return spring, gear shifting cam and feed cam.**

### **Optimizations**

The first compound gearing system is driven by its ring gear. We noticed in the section Locking direction of sun gears  $s$  that the sun gear needs to be blocked from turning counterclockwise. The planet cage always rotates clockwise along with the driver. Since the big sun gear will never reverse its direction if unlocked, if it is unlocked it will always rotate clockwise along with the planet cage. Therefore it does not need a control mechanism at all, just a ratchet on the axle.

When the clutch  $L$  is locked, both sun gears in compound gearing system 1 will rotate clockwise along with the cage. Since the ratchets never engage in this direction, they do not need to be unblocked. The Nexus 7 main control sleeve is optimized for this, and does not unlock sun gear 2 when  $L$  is engaged in the highest two gears.

In the second compound planetary gear system, the planet cage is always driven clockwise, and so the sun gears have to be blocked from turning clockwise. When freed, the smaller sun gear  $S4$  will rotate counterclockwise. Therefore  $S4$  does not need to be free when the bigger  $S3$  is blocked. We can recognize this optimization in the main

control sleeve. But, as the lowest two gear ratios of the hub need both sun gears to turn freely, active control of sun gear  $S_4$  is still necessary.

## Acknowledgements

I would like to thank Doc7speed and John Allen [6] for checking this document.

## References

[1] US Patent 5322487 (1994). Self-contained change speed apparatus with shaped pawls to equalize a shifting spring force for a bicycle. <http://patft.uspto.gov/>

[2] US Patent 5273500 (1993). Self-contained change speed apparatus for use on a bicycle and having a planetary gear mechanism. <http://patft.uspto.gov/>

[3] US Patent 5562563 (1996). Control system for a working apparatus for use on a bicycle. <http://patft.uspto.gov/>

[4] US Patent 7148582 (2006). Bicycle internal gear shifting hub. Available <http://patft.uspto.gov/>

[5] US Patent 2003/0130079 (2003). Bicycle hub transmission with power control mechanism for a shift assist mechanism. <http://patft.uspto.gov/>

[6] John S. Allen's Home Page (2003). <http://bikexpert.com>